

Project Documentation | UMRR Automotive Type 153 Data Sheet

Project Number:

SMS Project Number:

Project Title:

Automotive Radar Sensor

Keyword(s):

UMRR Automotive Sensor Data Sheet

Blind Spot Detection Radar

Collision Warning Radar

Date:

September 4, 2019

Document:

UMRR Automotive Type 153 Data Sheet.docx

PROPRIETARY

The information contained in this document may be subject to change without notice.

The information contained in this document shall remain the sole exclusive property of s.m.s smart microwave sensors GmbH.

Contents

1	User Safety Warning Information	3
2	Sensor Data Sheet	5
2.1	General Performance Data.....	6
2.2	Applications	7
2.3	Function Description.....	8
2.4	Multi-Mode Operation and Adaptive Beams.....	9
2.5	Object Separation Performance.....	10
2.6	Field of View.....	11
2.7	On-board Diagnostics (BIT)	14
2.8	Ethernet Connection.....	15
2.9	Compliance.....	16
2.10	Sensor Dimensions.....	17
2.11	Connector Pin-Out.....	18
3	Multi Sensor Systems	20
3.1	Configurations	20
3.2	Data Logging and Visualization Tools	20
4	Important Legal Disclaimer Notice.....	21
5	Contact	22

PROPRIETARY

The information contained in this document may be subject to change without notice.

The information contained in this document shall remain the sole exclusive property of s.m.s smart microwave sensors GmbH.

1 User Safety Warning Information

Read the instructions carefully before you start to work.

Installation

Please observe the following advices when installing and connecting the sensors:

- Only use the mounting straps with the 6mm holes to mount the sensor on the platform.
- Only skilled and instructed persons shall install and connect the devices. Proper experience in working with mains voltage, electrical and electronic devices is required.
- Don't connect the devices directly to mains voltage, instead use the voltage given in the manual.
- Don't wire any connections while power is applied to the device.
- Ground the devices carefully to prevent electrical shock.
- All connectors are pin-coded and fit in only one position. Also note the arrows indicating the top side of the sensor.
- Only use fully functional equipment (ladders, aerial work platform, ...) when working above ground. Staff shall be capable of working at heights.
- Use caution when installing the devices on or around active roadways. Pay attention to moving traffic.
- Mount the devices carefully to prevent them from shifting or dropping.
- The devices must be mounted to a stiff and solid support. Vibration, oscillation or any kind of movement will reduce the sensor performance.
- Make sure that your installation methods are in accordance with local safety policy and procedures and company practices.

Technical service

Only use provided or approved equipment for operation.

Persons other than authorized and approved electrical technicians shall NOT attempt to connect this unit to a power supply, Traffic Management Interface Board and/or other controllers, as there is a risk of electrical shock by unsafe handling of the power source.

Do not attempt to service or repair this unit.

- No user-maintainable parts are contained within the device.
- To avoid electrical shock, do not remove or open the cover.
- Unauthorized opening will void all warranties.
- Smartmicro is not liable for any damages or harms caused by unauthorized attempts to open or repair the device.

Radiation

This product has been tested and found to comply with Part 15 Subpart C of the Federal Communications Commission (FCC) or the European RED directive, or other national rules, depending on the country where it may be in use.

PROPRIETARY

The information contained in this document may be subject to change without notice.

The information contained in this document shall remain the sole exclusive property of s.m.s smart microwave sensors GmbH.

Operation is subject to the following two conditions:

1. This device may not cause harmful interference, and
2. This device must accept any interference received, including interference that may cause undesired operation.

This device generates radio frequency energy.

There are strict limits on continuous emission power levels. These limits are designed to provide reasonable protection against harmful interference when the equipment is operated in a commercial environment.

- Human exposure to transmitted waves from this device is generally considered as safe.
- Nevertheless, it is considered good practice that humans are not subject to higher radiation levels than necessary.
- This device may interfere with other devices using the same frequency band.

Operation

Transmission of radio frequency waves starts after the sensor is powered up and stops when disconnecting it from power.

For testing purposes, the sensor may be laid on its face when it is powered up, given that the surface or connectors will not be damaged by doing so. Please note that this position is not intended for permanent use.

It is recommended that only one connection interface is used at a time.

Do not operate the device if the device itself or any cables are damaged.

The sensors may become hot during operation, so proper hand protection is recommended for maintenance work.

PROPRIETARY

The information contained in this document may be subject to change without notice.

The information contained in this document shall remain the sole exclusive property of s.m.s smart microwave sensors GmbH.

2 Sensor Data Sheet

Smartmicro offers a family of automotive Radar sensors called UMRR – Universal Medium Range Radar.

A number of different antennas are available - so the permanent fixed field of view and max. range can be selected by the customer.

This data sheet describes the type 153 **4D/HD** High Definition antenna model.

Type 153 Antenna aims at short and medium range with very wide horizontal angular coverage, and features 3TX, 4RX, CMOS RFIC with Quad Core MCU.

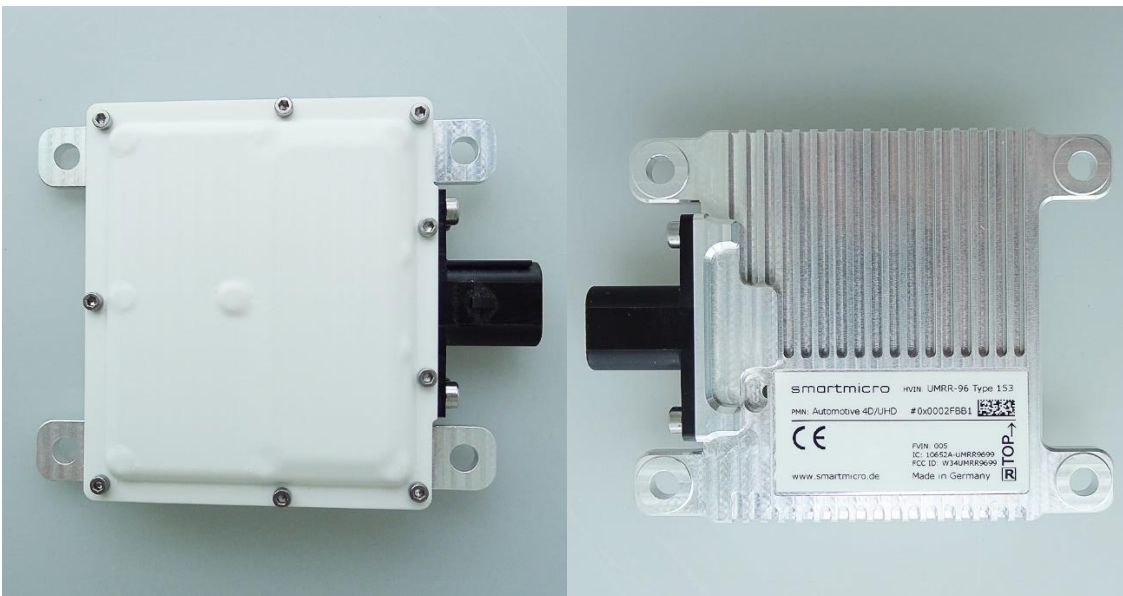

Figure 1: Automotive Sensor Type 153 – front and rear view

Also available on request:

- Other versions of the housing for OEM integration.
- Other connector options.
- Other physical interface options.

For more details please [contact us](#).

PROPRIETARY

The information contained in this document may be subject to change without notice.

The information contained in this document shall remain the sole exclusive property of s.m.s smart microwave sensors GmbH.

2.1 General Performance Data

Parameter		Specification		
		Long Range Mode	Medium Range Mode	Short Range Mode
Operating Frequency [GHz]		79 (77...81)	79 (77...81)	79 (77...81)
Range ^I	Min/Max [m] ^I	Min: 0.8 Max: 120	Min: 0.4 Max: 55	Min: 0.15 Max: 20
	Discrimination[m]	< 1.2	< 0.6	< 0.3
	Accuracy [m]	< 0.5 or 1% (bigger of)	< 0.3 or 1% (bigger of)	< 0.15 or 1% (bigger of)
Velocity	Min/Max [km/h] ^V	-340/+140	-340/+140	-400/+140
	Discrimination[m/s]	< 0.3	< 0.3	< 0.3
	Accuracy [m/s]	< 0.15	< 0.15	< 0.15
Angle ^{II}	FoV of Azimuth [°]	≥100 (squint beam)	≥130	≥130
	FoV of Elevation [°]	15	15	15
	Discrimination [°]	~30 (optional)	~30 (optional)	~30 (optional)
	Accuracy of Azimuth [°] ^{III}	≤ 1 (@<50° from boresight)		
	Accuracy of Elevation [°] ^{III}	≤ 2 (@<10° from boresight)		
Initialization Time [s]		< 4		
Update Cycle Time [ms]		≤ 55		
Processing Latency [ms]		2-4 Cycles		
Operating Voltage [V] ^{IV}		8 ~ 24		
Power Consumption [W]		< 5		
Max. Transmit Power (EIRP) [dBm]		<25		
Operating Temperature [°C]		-40 ~ +85		
Storage Temperature [°C]		-45 ~ +125		
Sensor Weight [g]		≤ 153		
Dimension (H/W/D) [mm]		97x80x17.7 plus connector 103.8x80x22.45 incl. connector		
Interfaces		Primary CAN V2.0b (passive) (CAN FD 2Mbit/s sleep mode capable optional by software) Secondary CAN FD 5Mbit/s (optional by software) 2-wire Automotive Ethernet 100Mbit (optional by software) TJA1100 Compliance with 100BASE-T1 IEEE 802.3bw		
Connector		8 Pin plug ACES / TE Connectivity		
Model No.		UMRR-96xxxx		
Shock [g _{rms}]		100		
Vibration [g _{rms}]		14		
IP		67		
Pressure / Transport altitude [m]		0...10.000		

Table 1: Performance Parameters

^I Typical values; may vary to higher or lower values depending on clutter environment. All values given for bore sight. Please note that the Radar system – like any other sensor system – although being well optimized and providing excellent performance, will not achieve a 100% detection probability and will not achieve a false alarm rate equal to zero. Presence detection below is available. Minimum range may be reduced customer specific depending on local frequency regulations.

^{II} Total field of view is angle interval where reflectors can be detected; 3dB field of view is narrower. Accuracy specified at bore sight. Angular accuracy specified at bore sight, falls off towards larger angles.

PROPRIETARY

The information contained in this document may be subject to change without notice.

The information contained in this document shall remain the sole exclusive property of s.m.s smart microwave sensors GmbH.

III Measured for point reflector at bore sight with >23dB S/N. Falls off toward larger absolute angles.

IV Measured at connector.

2.2 Applications

The sensor is very versatile and can be used for all kind of 360 degree short- and medium range applications.

The sensor is especially well suited for all kind of blind spot detection (BSD) and lane change assist (**LCA**) applications. It can be applied for short- and medium range collision warning (CW) applications for **autonomous driving**.

One or multiple sensors are specifically integrated into vehicle models of automotive OEMs. Usually there is a certain OEM-specific engineering effort required for the adaptation to specific vehicle models and the test and qualification procedures to be applied. Customer specific connectors, CAN(FD)/Ethernet interfaces, tracking algorithms, warning algorithms or other custom software packages can be included.

Examples:

- Blind Spot Detection (**BSD**).
- Lane Change Assist (**LCA**)
- Rear and front Cross Traffic Alert (**RCTA/FCTA**).
- Warning to open door if object approaches from behind.
- Rear and side **Pre-Crash/Pre-Safe** applications.
- **Parking** assistance
- Front, rear and side Collision Warning (**CW**), 360degree collision warning
- **Autonomous driving**

Functional Safety:

This sensor can optionally be compliant to ASIL Level B in customer specific projects (requirements and safety concept to be agreed between OEM and smartmicro).

AUTOSAR:

This sensor can optionally be offered with AUTOSAR compliant software in customer specific projects (specification to be agreed between OEM and smartmicro).

PROPRIETARY

The information contained in this document may be subject to change without notice.

The information contained in this document shall remain the sole exclusive property of s.m.s smart microwave sensors GmbH.

2.3 Function Description

The sensor is a small, lightweight, very robust low cost 79 GHz Radar for automotive applications. It is intended for multiple applications and can be used almost worldwide in this frequency band.

It works in adverse conditions, almost unaffected by weather, and independent of sunlight, in a wide temperature interval. The radar withstands high shock and vibration levels, is maintenance free and made for a long lifetime.

Using a patented transmit signal waveform, each individual sensor measures range, radial speed, azimuth and elevation angle, reflectivity and other parameters of multiple stationary and moving reflectors (**targets**) simultaneously. Having multi target capability, the sensor will report many reflectors at a time being within the field of view (**target list**):

- Range
- Az. and El. Angle
- Radial Speed
- Reflectivity
- Other...

Additional (optional) filter algorithms are implemented (for certain applications) for the tracking of all detected reflectors over time, those tracking algorithms are integrated in the sensor. Multiple **objects** are tracked simultaneously; the individual reflectors are separated in the detection algorithms by having a different radial speed value and/or different range value and/or by different az. angles, as well as by the tracking algorithms and data base. The result of the tracking is an **object list** with the following parameters:

- x position
- y position
- x component of the velocity
- y component of the velocity
- other...

Finally based on all detected targets and tracked objects in the field of view a function/application algorithm can optionally be implemented, like a **blind spot warning** or **collision warning** signal.

Hence the sensor optionally reports such a list of all tracked objects, including stationary objects, inside its field of view in every measurement cycle of typ. 50ms length.

In addition to that, status and diagnose data from the sensor are reported.

PROPRIETARY

The information contained in this document may be subject to change without notice.

The information contained in this document shall remain the sole exclusive property of s.m.s smart microwave sensors GmbH.

2.4 Multi-Mode Operation and Adaptive Beams

Note that UMRR-96 type 153 also **allows to switch between short, medium and long range mode.**

Moreover, UMRR-96 type 153 allows **adaptive beams**, it can be switched between straight beam and a ~ 30 degree off bore sight squinting beam.

Any mode can be selected for any beam.

HIGH DEFINITION RADAR PERFORMANCE

4D/HD

- Separation in Speed
- Separation in Range
- High Speed Modulation
- Adaptive Beams

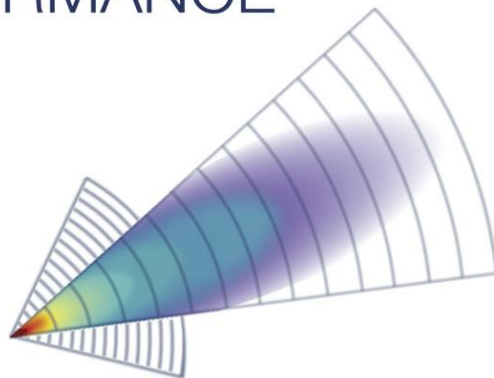

Figure 2: 4D/HD graphical illustration for short range mode straight beam and long range mode with straight beam.

HIGH DEFINITION RADAR PERFORMANCE

4D/HD

- Separation in Speed
- Separation in Range
- High Speed Modulation
- Adaptive Beams

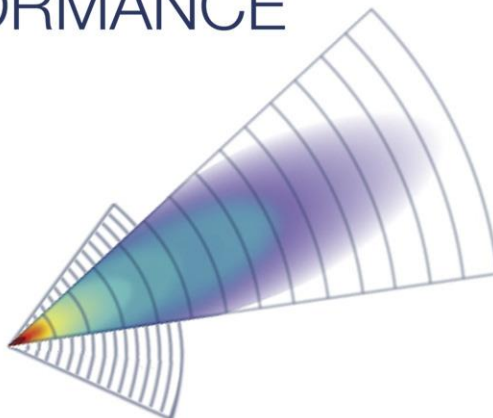

Figure 3: 4D/HD graphical illustration for short range mode straight beam and long range mode with squinting beam.

PROPRIETARY

The information contained in this document may be subject to change without notice.

The information contained in this document shall remain the sole exclusive property of s.m.s smart microwave sensors GmbH.

2.5 Object Separation Performance

UMRR-96 features the latest technology automotive radar sensors: **4D/HD**. For each reflector, there is a true **4D** measurement of range, Doppler, azimuth and elevation angle.

UMRR-96 can accomplish range gate specific and even Doppler gate specific detection of moving and even stationary vehicles.

The sensor provides excellent target separation (HD). Individual reflectors are separated in the detection algorithms by:

- a) having a different radial speed value **OR**
- b) having a different range value **OR**
- c) having a different azimuth angular position (optional).

PROPRIETARY

The information contained in this document may be subject to change without notice.

The information contained in this document shall remain the sole exclusive property of s.m.s smart microwave sensors GmbH.

2.6 Field of View

The sensor features squinting and straight antennas. Squinting antennas can be used for applications like RCTA/FCTA, where the max. range is required off boresight, i.e. at ~ 30 degree offset to the mechanical mount axis.

Straight antennas have their max. range at bore sight. A typical configuration is shown below.

The figures below show typical multiple sensors configuration with 360° field of view and for rear collision warning as well as blind spot detection.

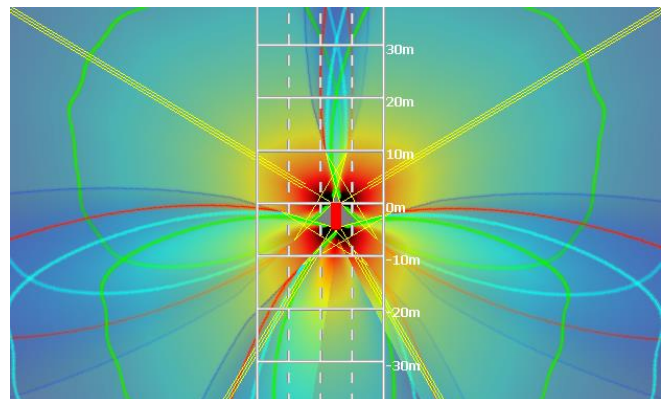
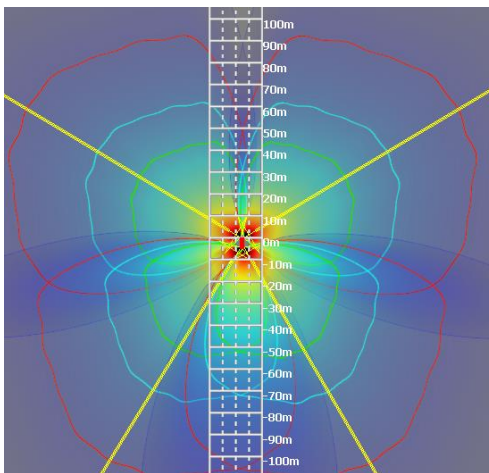
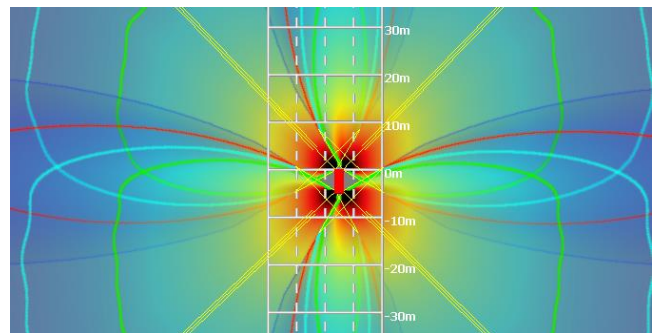
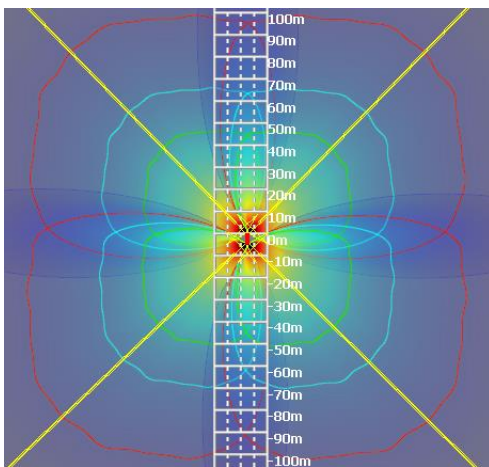

Figure 4: Four sensors configuration and 360° field of view by using straight antennas.

PROPRIETARY

The information contained in this document may be subject to change without notice.

The information contained in this document shall remain the sole exclusive property of s.m.s smart microwave sensors GmbH.

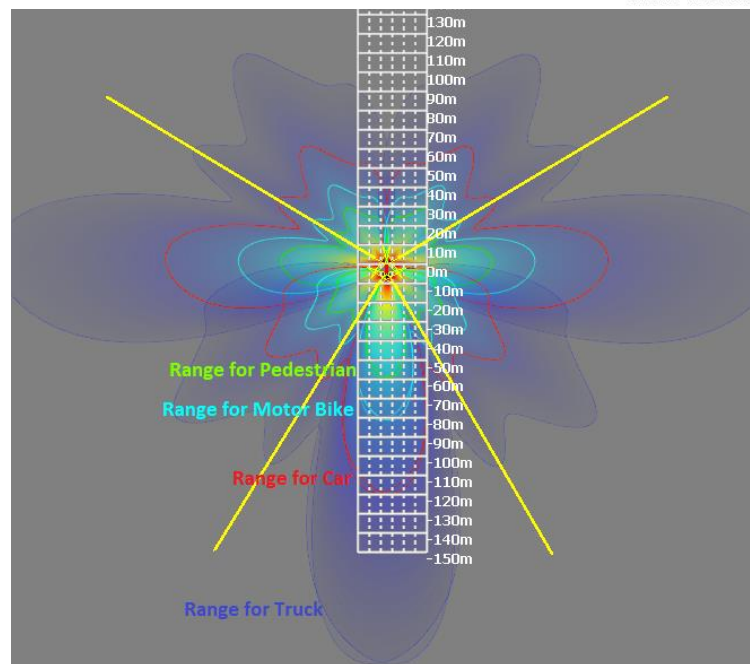

Figure 5: Four sensors configuration and 360° field of view 4x squinting antennas active.

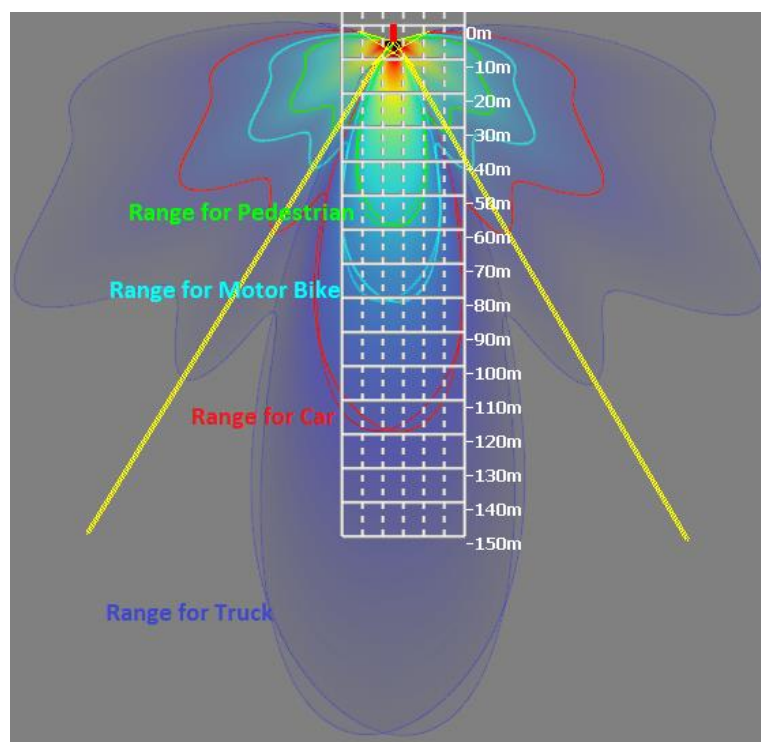

Figure 6: Two sensors configuration for BSD plus rear collision warning – 2x squint antenna active.

PROPRIETARY

The information contained in this document may be subject to change without notice.

The information contained in this document shall remain the sole exclusive property of s.m.s smart microwave sensors GmbH.

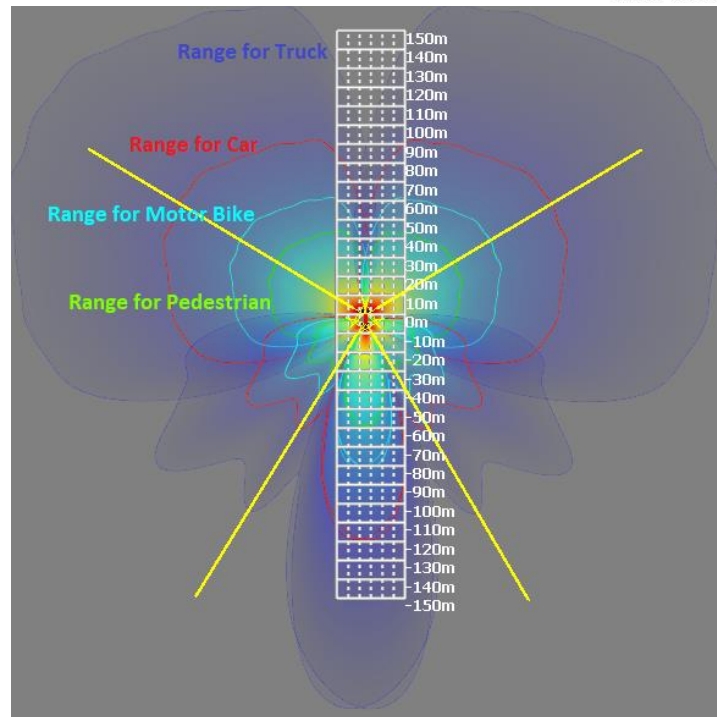

Figure 7: Four sensors configuration and 360° field of view by using 2xstraight (front) and 2xsquinting antennas (rear).

PROPRIETARY

The information contained in this document may be subject to change without notice.

The information contained in this document shall remain the sole exclusive property of s.m.s smart microwave sensors GmbH.

2.7 On-board Diagnostics (BIT)

The UMRR sensor cyclically reports a status message providing the following information (Continuous BIT)

- Sensor run time
- Sensor cycle time
- Sensor mode
- Other status bits

Initiated BIT is available. Sensor will send BIT results when it receives a command to do so.

PROPRIETARY

The information contained in this document may be subject to change without notice.

The information contained in this document shall remain the sole exclusive property of s.m.s smart microwave sensors GmbH.

2.8 Ethernet Connection

The sensor supports UDP over Ethernet in a Local Area Network (LAN). Communication over low bandwidth environments or routed networks e.g. the world wide web is not supported.

Features:

1. Ethernet standards IPv4, ARP, IGMP, IP multicast and UDP
2. Supports DHCP
3. Smartmicro proprietary communication protocol "sms Transport" with:
 - IP/UDP Multicast based discovery protocol
 - Client ID based setup
 - Sensor data transmission

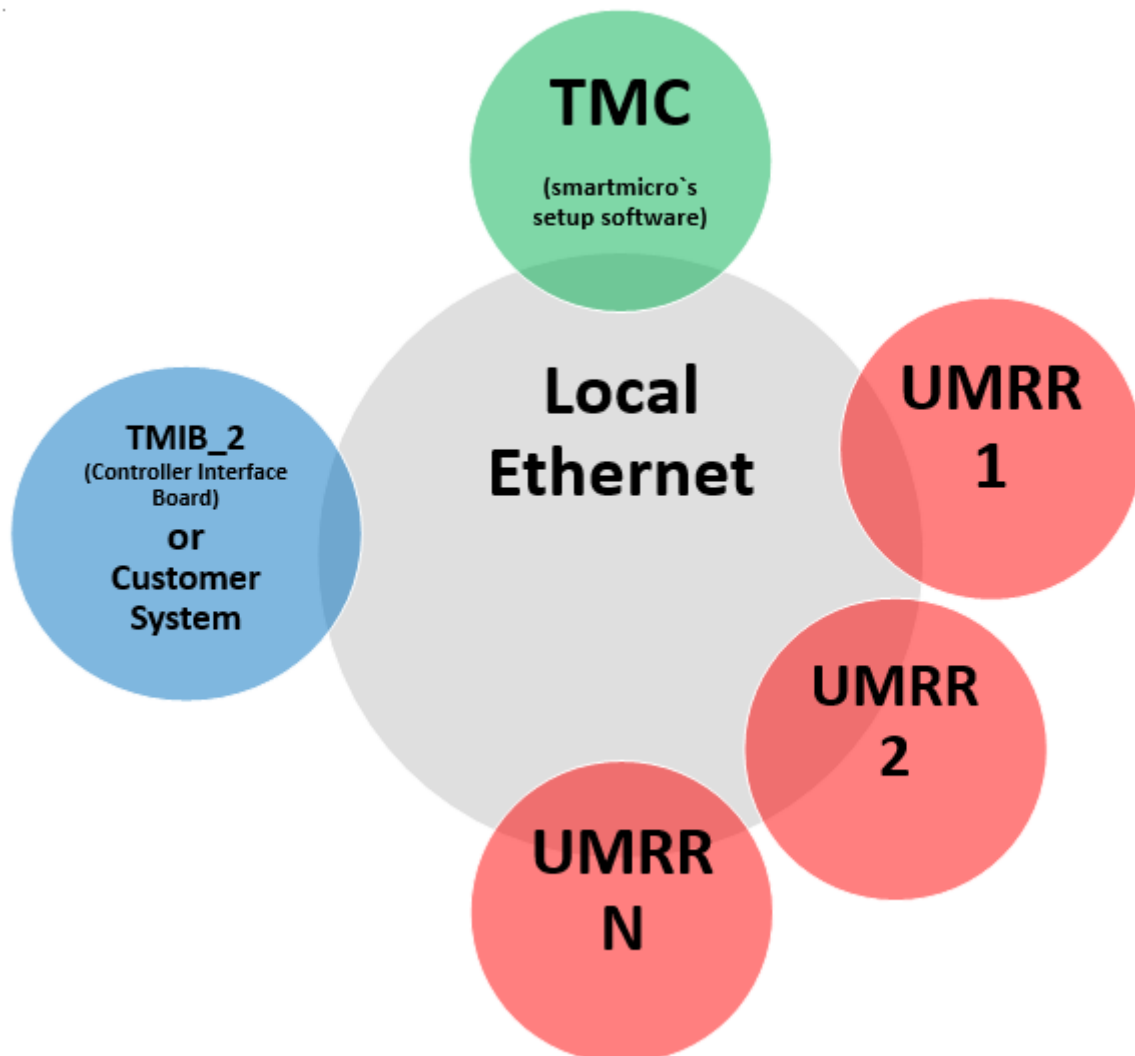

Figure 8: Standard Use Case - TMC, TMIB_2 or Customer System and UMRR in a Local Ethernet

PROPRIETARY

The information contained in this document may be subject to change without notice.

The information contained in this document shall remain the sole exclusive property of s.m.s smart microwave sensors GmbH.

2.9 Compliance

The sensor model complies with the following EU directives:

- RED 2014/53/EU
- RoHS 2011/65/EU
- EC 1907/2006 REACH

Applied Standards under RED 2014/53/EU:

- Spectrum Usage:
 - o EN 302 264 V2.1.1
- EMC:
 - o EN 301 489-1 V2.2.0
 - o EN 301 489-51 V2.1.0
- Health and Safety:
 - o EN 62311: 2008
 - o EN 62368-1: 2014 + AC: 2015

Regarding spectrum usage, the sensor model has been tested and certified according to the following standards and/or other normative documents:

- EU RED 2014/53/EU (formally approved by test lab or notified body),
- FCC part 95M (formally approved by test lab or notified body),
- ISED RSS-251 (formally approved by test lab or notified body)

This sensor model is also generally compliant with the following regional regulations (but may not be formally tested/approved):

- SRRC,
- KCC,
- MIIT,
- NCC.

Note: This statement of compliance means that the sensor device allows operation compliant to the listed standards. However, not all standards are certified through test labs and not for all countries formal frequency approval/registration is accomplished.

In certain countries or regions a customer-specific local frequency approval is reasonable. Smartmicro supports customers for this process.

PROPRIETARY

The information contained in this document may be subject to change without notice.

The information contained in this document shall remain the sole exclusive property of s.m.s smart microwave sensors GmbH.

2.10 Sensor Dimensions

All values are given in mm.

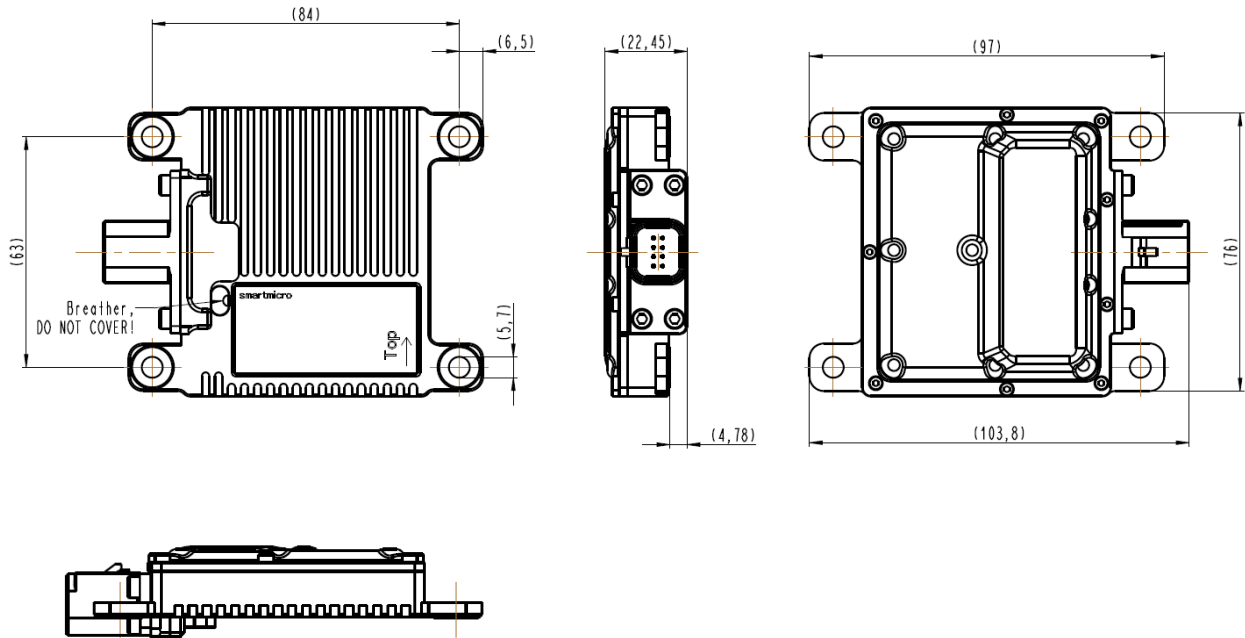

Figure 8: Sensor Dimensions

PROPRIETARY

The information contained in this document may be subject to change without notice.

The information contained in this document shall remain the sole exclusive property of s.m.s smart microwave sensors GmbH.

2.11 Connector Pin-Out

The sensor connector mates with an 8-pin female connector for automotive interconnections (TE 1411001-1: water proof IP67, manufacturer TE). The pin numbering of the female connector is shown in Figure 9. The pin-out of the connector is shown in Table 1.

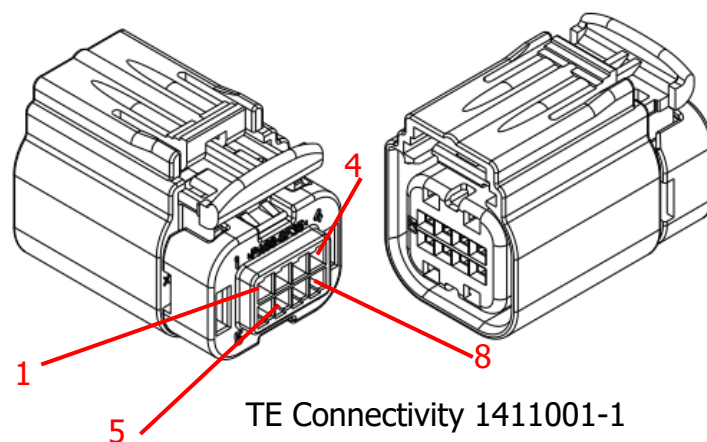
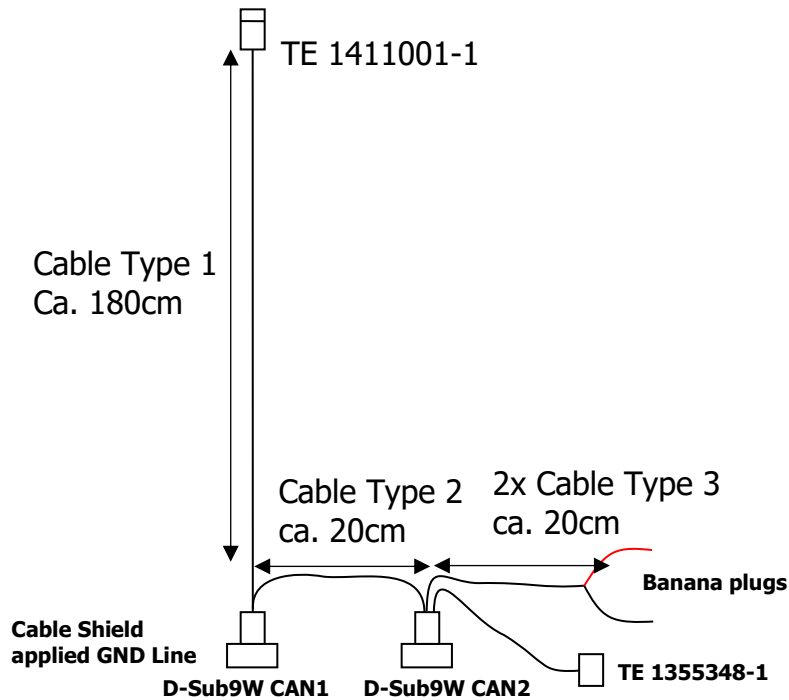

Figure 9: Diagram of cable-FF025 and rear view of female counterpart

PROPRIETARY

The information contained in this document may be subject to change without notice.

The information contained in this document shall remain the sole exclusive property of s.m.s smart microwave sensors GmbH.

Table 1: Sensor connector pin-out

TE 1411001-1	Pair	Label	DSUB-9-w CAN1	DSUB-9-w CAN2	Banana plug	TE 1355348-1
1	1	GND	3	3	Black	
2	2	BroadR_P				9
3	3	CAN2_H		7		
4	3	CAN2_L		2		
5	1	V+			Red	
6	2	BroadR_N				8
7	4	CAN1_H	7			
8	4	CAN1_L	2			
	-	SHIELD	3			

Please note that in the standard configuration the sensor has a CAN bus termination between CAN_L and CAN_H (120 Ohms resistor on board).

A termination (resistor) is required at either end of a CAN bus and it is not integrated in the cable delivered along with the sensor (Cable FF0025, manufactured by Smartmicro).

PROPRIETARY

The information contained in this document may be subject to change without notice.

The information contained in this document shall remain the sole exclusive property of s.m.s smart microwave sensors GmbH.

3 Multi Sensor Systems

3.1 Configurations

The sensor may be used standalone or multiple sensors can be connected in a network. Such networks are only possible using CAN(FD) interface. Sensors in the network work plug and play, free of mutual interference.

Customer specific configurations are possible.

3.2 Data Logging and Visualization Tools

Visualization of all data (i.e. **target lists**, **object lists**, other) is possible using the [Drive Recorder](#) software on any PC, as well as data logging, associated video documentation, play back and analysis functions and more.

Instead of the [Drive Recorder](#), other customer specific visualization, logging, or function/application software products may be applied; the radar system's data interface is easy to integrate.

PROPRIETARY

The information contained in this document may be subject to change without notice.

The information contained in this document shall remain the sole exclusive property of s.m.s smart microwave sensors GmbH.

4 Important Legal Disclaimer Notice

All Product, Product specifications and data in this project documentation are subject to change without notice to improve reliability, function, design or otherwise.

The statements, technical information and recommendations contained herein are believed to be accurate as of the date hereof. Smartmicro disclaims any and all liability for any errors, inaccuracies or incompleteness contained in this datasheet or in any other disclosure relating to the Product.

To the extent permitted by applicable law, Smartmicro disclaims (i) any and all liability arising out of the application or use of the Product or the data contained herein, (ii) any and all liability of damages exceeding direct damages, including - without limitation – indirect, consequential or incidental damages, and (iii) any and all implied warranties, including warranties of suitability of the Product for a particular purpose.

Statements regarding the suitability of Products for certain types of applications are based on Smartmicro' knowledge of typical requirements that are often placed on Smartmicro' Products in generic/general applications. Such statements are, however, not binding statements about the suitability of Products for a particular/specific application. It is the customer/user's own responsibility to validate that the Product with the specifications described herein is suitable for use in its particular/specific application. Parameters and performance of the Products may due to particular/specific applications and due to particular/specific surroundings deviate from the statements made herein. Therefore, it is important that customer/user has thoroughly tested the Products and has understood the performance and the limitations of the Products before installing the Products for the final applications or before commercialization. Although Products are well optimized to be used for the intended applications stated herein, it must also be understood by the customer/user that the detection probability may not be 100 % and the false alarm rate may not be zero.

The information provided herein, relates only to the specific Product designated and may not be applicable when such Product is used in combination with other materials or in any process not defined herein. All operating parameters, including typical parameters, must be validated for each customer application by the customer/user's technical experts. Customers using or selling Smartmicro products not expressly indicated for use in such applications do so at their own risk.

This Product specification or data sheet does not expand or otherwise modify Smartmicro terms and conditions of purchase, including but not limited to the warranty expressed therein.

Except as expressly indicated in writing by Smartmicro, the Products are not designed for use in medical, life-saving, or life-sustaining applications or for any other application in which the failure of the Product could result in personal injury or death.

No license, express or implied, by estoppel or otherwise, to any intellectual property rights is granted by this document or by any conduct of Smartmicro Product names and markings noted herein may be trademarks of their respective owners.

Please note that the application of the Product may be subject to standards or other regulations that may vary from country to country. Smartmicro does not guarantee that the use of Products in the applications described herein will comply with such regulations in any country. It is the customer/user's responsibility to ensure that the use and incorporation of Products complies with the regulatory requirements of their markets.

If any provision of this Disclaimer is, or is found to be, void or unenforceable under applicable law, that will not affect the validity or enforceability of the other provisions of this Disclaimer.

PROPRIETARY

The information contained in this document may be subject to change without notice.

The information contained in this document shall remain the sole exclusive property of s.m.s smart microwave sensors GmbH.

5 Contact

Address:

smart microwave sensors GmbH
In den Waashainen 1
38108 Braunschweig
Germany

Phone / Fax numbers:

Phone: +49-531-39023-0
Fax: +49-531-39023-599

Web / Email address:

Web: www.smartmicro.de
Email: info@smartmicro.de

PROPRIETARY

The information contained in this document may be subject to change without notice.

The information contained in this document shall remain the sole exclusive property of s.m.s smart microwave sensors GmbH.